

High Voltage Standard Rectifier Module

$$V_{RRM} = 2 \times 3400 \text{ V}$$

$$I_{FAV} = 240 \text{ A}$$

$$V_F = 1.01 \text{ V}$$

Phase leg

Part number

MDD175-34N1

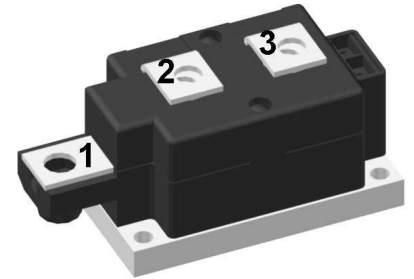

Backside: isolated

 E72873



Features / Advantages:

- Planar passivated chips
- Very low leakage current
- Very low forward voltage drop
- Improved thermal behaviour

Applications:

- Diode for main rectification
- For single and three phase bridge configurations
- Supplies for DC power equipment
- Input rectifiers for PWM inverter
- Battery DC power supplies
- Field supply for DC motors

Package: Y1

- Isolation Voltage: 4800 V~
- Industry standard outline
- RoHS compliant
- Base plate: Copper internally DCB isolated
- Advanced power cycling

Terms Conditions of usage:

The data contained in this product data sheet is exclusively intended for technically trained staff. The user will have to evaluate the suitability of the product for the intended application and the completeness of the product data with respect to his application. The specifications of our components may not be considered as an assurance of component characteristics. The information in the valid application- and assembly notes must be considered. Should you require product information in excess of the data given in this product data sheet or which concerns the specific application of your product, please contact your local sales office.

Due to technical requirements our product may contain dangerous substances. For information on the types in question please contact your local sales office.

Should you intend to use the product in aviation, in health or life endangering or life support applications, please notify. For any such application we urgently recommend

- to perform joint risk and quality assessments;

- the conclusion of quality agreements;

- to establish joint measures of an ongoing product survey, and that we may make delivery dependent on the realization of any such measures.

Rectifier				Ratings			
Symbol	Definition	Conditions		min.	typ.	max.	Unit
V_{RSM}	max. non-repetitive reverse blocking voltage			$T_{VJ} = 25^{\circ}C$		3500	V
V_{RRM}	max. repetitive reverse blocking voltage			$T_{VJ} = 25^{\circ}C$		3400	V
I_R	reverse current	$V_R = 3400 V$		$T_{VJ} = 25^{\circ}C$		1	mA
		$V_R = 3400 V$		$T_{VJ} = 150^{\circ}C$		5	mA
V_F	forward voltage drop	$I_F = 200 A$		$T_{VJ} = 25^{\circ}C$		1.07	V
		$I_F = 400 A$				1.26	V
		$I_F = 200 A$		$T_{VJ} = 125^{\circ}C$		1.01	V
		$I_F = 400 A$				1.26	V
I_{FAV}	average forward current	$T_C = 100^{\circ}C$		$T_{VJ} = 150^{\circ}C$		240	A
		180° sine	d = 0.5				
V_{FO}	threshold voltage	} for power loss calculation only				0.74	V
r_F	slope resistance					1.27	mΩ
R_{thJC}	thermal resistance junction to case					0.14	K/W
R_{thCH}	thermal resistance case to heatsink			0.04			K/W
P_{tot}	total power dissipation			$T_C = 25^{\circ}C$		900	W
I_{FSM}	max. forward surge current	t = 10 ms; (50 Hz), sine		$T_{VJ} = 45^{\circ}C$		8.50	kA
		t = 8,3 ms; (60 Hz), sine		$V_R = 0 V$		9.18	kA
		t = 10 ms; (50 Hz), sine		$T_{VJ} = 150^{\circ}C$		7.23	kA
		t = 8,3 ms; (60 Hz), sine		$V_R = 0 V$		7.81	kA
I^2t	value for fusing	t = 10 ms; (50 Hz), sine		$T_{VJ} = 45^{\circ}C$		361.3	kA ² s
		t = 8,3 ms; (60 Hz), sine		$V_R = 0 V$		350.6	kA ² s
		t = 10 ms; (50 Hz), sine		$T_{VJ} = 150^{\circ}C$		261.0	kA ² s
		t = 8,3 ms; (60 Hz), sine		$V_R = 0 V$		253.4	kA ² s
C_J	junction capacitance	$V_R = 1100 V; f = 1 MHz$		$T_{VJ} = 25^{\circ}C$		182	pF

Package Y1				Ratings			
Symbol	Definition	Conditions	min.	typ.	max.	Unit	
I_{RMS}	RMS current	per terminal			600	A	
T_{VJ}	virtual junction temperature		-40		150	°C	
T_{op}	operation temperature		-40		125	°C	
T_{stg}	storage temperature		-40		125	°C	
Weight					680	g	
M_D	mounting torque		4.5		7	Nm	
M_T	terminal torque		11		13	Nm	
$d_{Spp/App}$	creepage distance on surface striking distance through air	terminal to terminal	16.0			mm	
$d_{Spb/Apb}$		terminal to backside	16.0			mm	
V_{ISOL}	isolation voltage	t = 1 second	4800			V	
		t = 1 minute	4000			V	

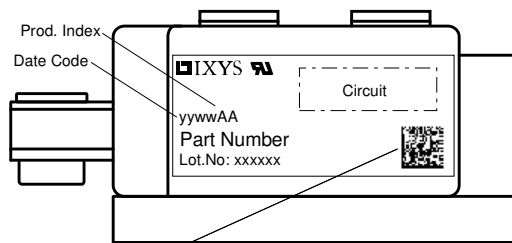

Data Matrix: Typ (1-19), DC+Prod.Index (20-25), FKT# (26-31)
leer (33), lfd.# (33-36)

Ordering	Ordering Number	Marking on Product	Delivery Mode	Quantity	Code No.
Standard	MDD175-34N1	MDD175-34N1	Box	3	504075

Equivalent Circuits for Simulation
** on die level*
 $T_{VJ} = 150\text{ °C}$

Rectifier

$V_{0\ max}$	threshold voltage	0.74	V
$R_{0\ max}$	slope resistance *	0.75	mΩ

Outlines Y1

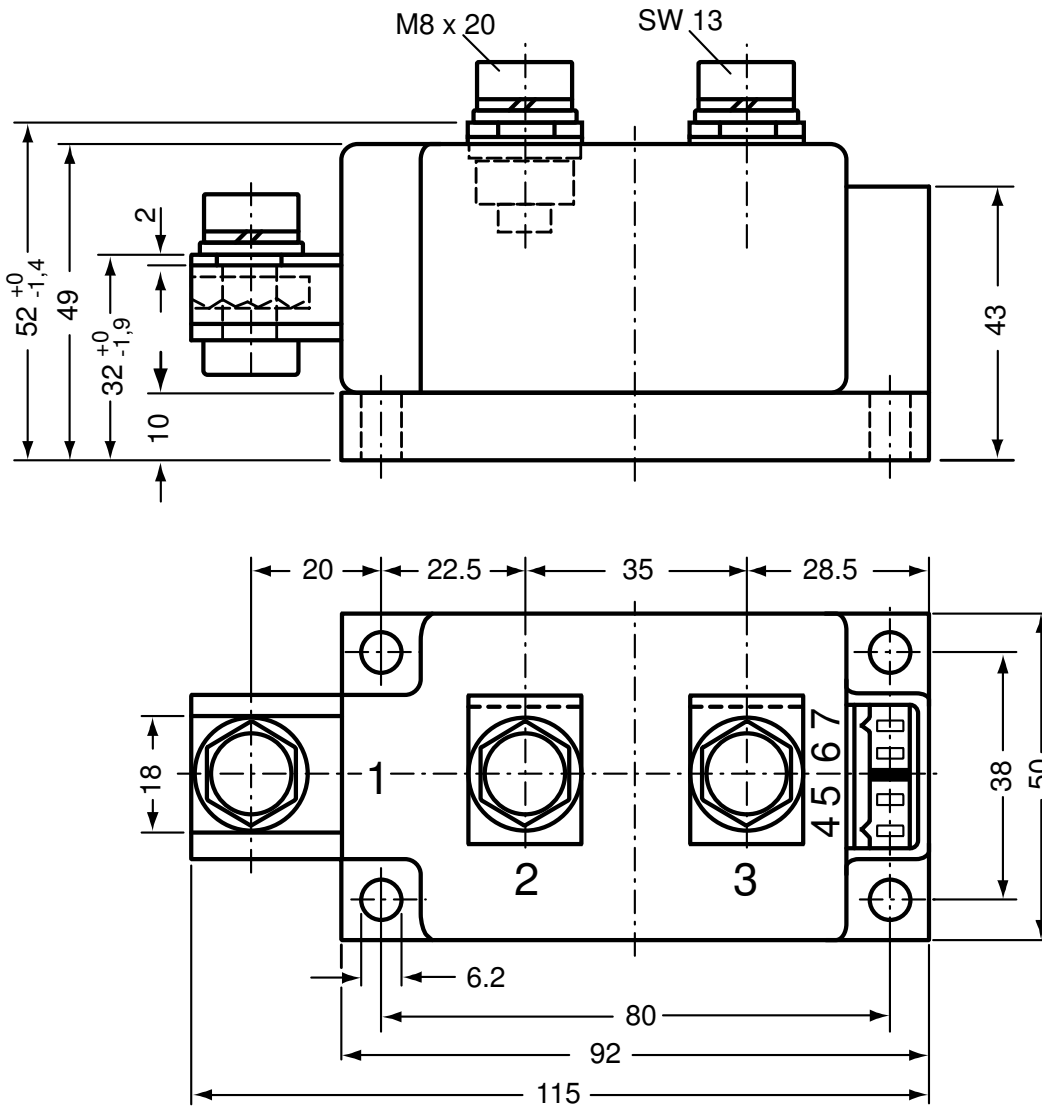

Optional accessories for modules

Keyed gate/cathode twin plugs with wire length = 350 mm, gate = white, cathode = red

Type ZY 180L (L = Left for pin pair 4/5) } UL 758, style 3751
 Type ZY 180R (R = Right for pin pair 6/7) }

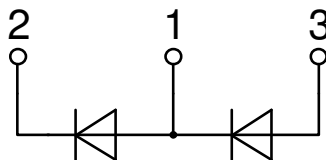

Rectifier

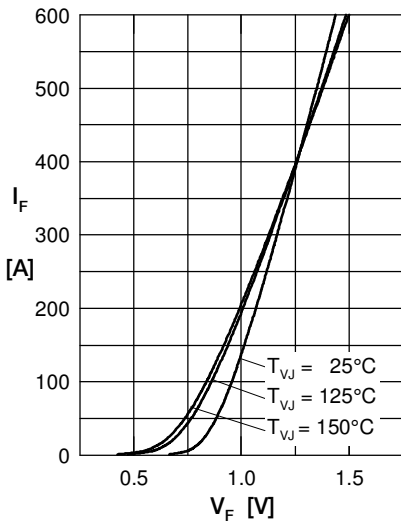

Fig. 1 Forward current versus voltage drop per diode

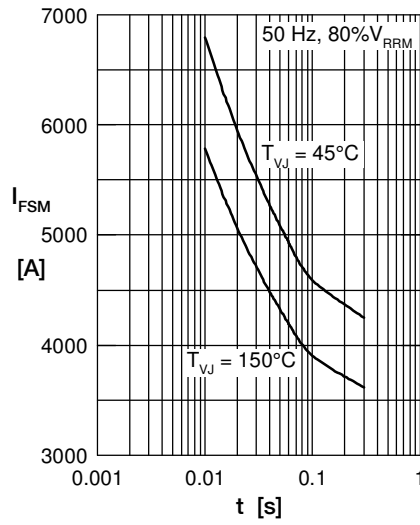

Fig. 2 Surge overload current

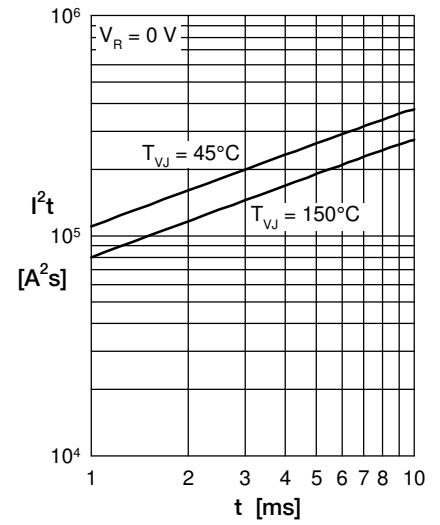

Fig. 3 I^2t versus time per diode

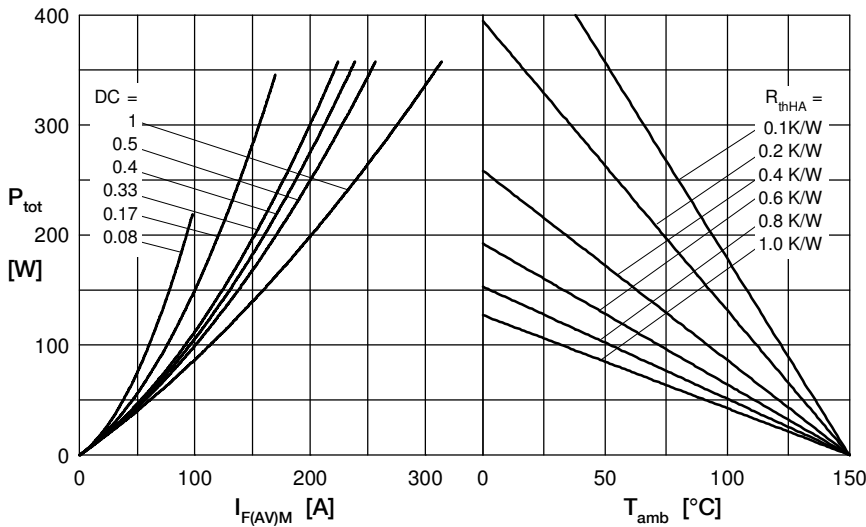

Fig. 4 Power dissipation vs. direct output current and ambient temperature

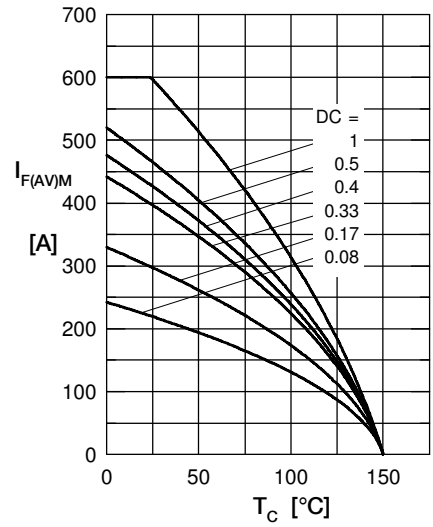

Fig. 5 Max. forward current vs. case temperature

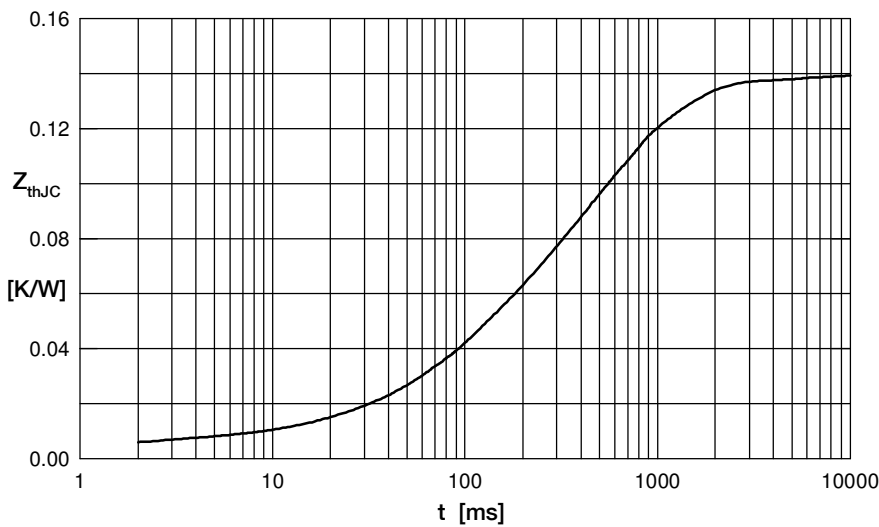

Fig. 6 Transient thermal impedance junction to case

Constants for Z_{thJC} calculation:

i	R_{thi} (K/W)	t_i (s)
1	0.155	0.0005
2	0.332	0.0095
3	0.713	0.17
4	0.3	0.8
5	0.00001	0.00001